

# HMR512DL 2mm pitch rear I/O connector systems



## Features and Benefits

- By color coding connector and shroud, work efficiency is enhanced.
- Keying and coloring is used to prevent misconnection. Black shroud can be connected with any color connectors.
- Double lock mechanism prevents the lock from disengaging even if the cable is pulled.

### Product Number

Connector Assy  
M30-3030-0X

- 01 Brown
- 02 Red
- 03 Orange
- 04 Yellow
- 05 Green
- 06 Blue
- 07 Purple
- 08 Gray

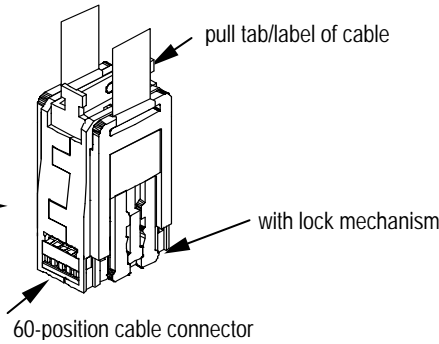

Shroud  
M20-1173-0X

- 00 Black
- 01 Brown
- 02 Red
- 03 Orange
- 04 Yellow
- 05 Green
- 06 Blue
- 07 Purple
- 08 Gray

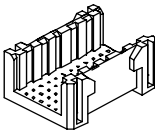

Spacer for 1mm  
M20-1099-01

Spacer for 2mm  
M20-1099-02

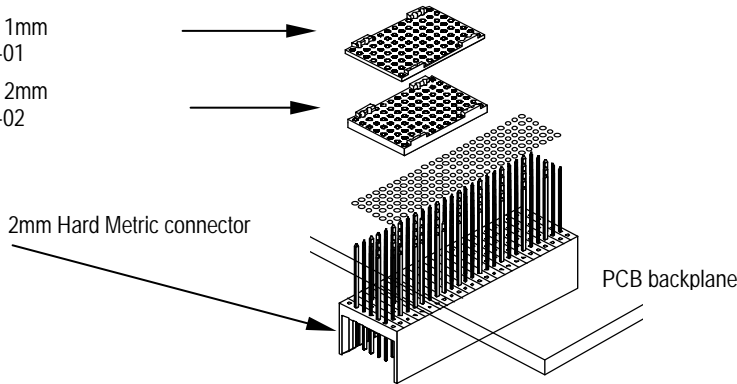

## Dimension

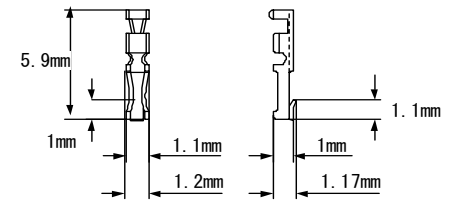
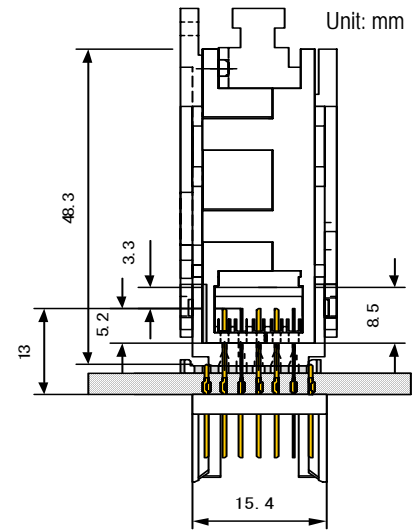

Socket contact MA39-2630-SCFC

The socket contact uses the clip method.  
This will accept AWG#26-AWG30.  
It will also accept AWG#24 with a thin mold.



Picture of Connector Assembly

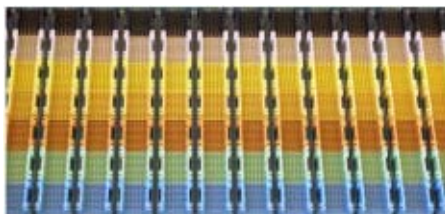

Picture of Shroud

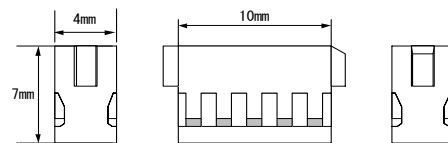

10-position socket housing

Socket housing is organizing 10 positions  
(2 X 5) and it has pin to fix shell inside